



The Global Language of Business

Receiving Advice Business Message Standard (BMS)

Release 3.4.1, Draft, Nov 2019



Document Summary

Document Item	Current Value
Document Name	Receiving Advice Business Message Standard (BMS)
Document Date	Nov 2019
Document Version	3.4.1
Document Issue	1
Document Status	Draft

Work Request Reference

Date of WR Submission to GSMP:	WR Submitter(s):	Refer to Work Request (WR) Number(s):
15-Oct-2009	GS1 Australia, GS1 Germany, GS1 Netherlands	09-000240
15-Oct-2009	GS1 Australia, GS1 Germany, GS1 Netherlands	09-000239
15-Oct-2009	GS1 Australia, GS1 Germany, GS1 Netherlands	09-000238
15-Oct-2009	GS1 Australia, GS1 Germany, GS1 Netherlands	09-000236
20- Aug-2008	GS1 Global Office	08-000209
29- Aug- 2007	Novozymes A/S	07-000408
05-Nov-2008	GS1 Global Office	04-000211
13-Dec-2013	GS1 Germany	13-000203
07-Feb-2014	GS1 Germany	14-000021
20-Mar-2014	GS1 Slovenia	14-000044
20-May-2013	GS1 Germany	14-000084
25-Jun-2014	GS1 Global Office	14-000110
11-Sep-2015	GS1 US	15-000282
28-Oct-2015	Philips N.V.	15-000314
08-Apr-2016	GS1 France	16-000245
18-Jun-2017	GS1 France	17-000034
18-Jun-2017	GS1 France	17-000042
22-Jun-2018	GS1 France	18-000136
03-Oct-2018	GS1 Global Office	18-000319

Business Requirements Document (BRAD) Reference

BRAD Title:	
BRAD Upstream Standards – Despatch, Receipt & Consumption	GS1, 2004
BRD Receiving Advice – Business Requirement Document	GS1, 2004
BRAD for Current Requirements Queue (Major Release 3)	GS1, 2010
BRAD Warehousing Inbound & Outbound Processes	GS1, 2012

Document Change History

Date of Change	Version	Changed By	Reason for Change	Summary of Change
12-Jan-2012	BMS 3.0 – Issue 1	Mark Van Eeghem	BMS Release 3.0	See summary of changes
01-May-2013	BMS 3.1 – Issue 1	Coen Janssen	BMS Release 3.1	See summary of changes
15-Sep-2014	BMS 3.2 – Issue 1	Ewa Iwicka	BMS Release 3.2	See summary of changes
01-Mar-2017	BMS 3.3 – Issue 1	Ewa Iwicka	BMS Release 3.3	See summary of changes
15-Oct-2018	BMS 3.4 – Draft for community review	Ewa Iwicka	BMS Release 3.4	See summary of changes
08-Nov-2019	BMS 3.4.1 – Issue 1	Radhika Chauhan	BMS Release 3.4.1	See summary of changes

Disclaimer

GS1®, under its IP Policy, seeks to avoid uncertainty regarding intellectual property claims by requiring the participants in the Work Group that developed this **Receiving Advice Business Message Standard (BMS)** to agree to grant to GS1 members a royalty-free licence or a RAND licence to Necessary Claims, as that term is defined in the GS1 IP Policy. Furthermore, attention is drawn to the possibility that an implementation of one or more features of this Specification may be the subject of a patent or other intellectual property right that does not involve a Necessary Claim. Any such patent or other intellectual property right is not subject to the licencing obligations of GS1. Moreover, the agreement to grant licences provided under the GS1 IP Policy does not include IP rights and any claims of third parties who were not participants in the Work Group.

Accordingly, GS1 recommends that any organization developing an implementation designed to be in conformance with this Specification should determine whether there are any patents that may encompass a specific implementation that the organisation is developing in compliance with the Specification and whether a licence under a patent or other intellectual property right is needed. Such a determination of a need for licencing should be made in view of the details of the specific system designed by the organisation in consultation with their own patent counsel.

THIS DOCUMENT IS PROVIDED “AS IS” WITH NO WARRANTIES WHATSOEVER, INCLUDING ANY WARRANTY OF MERCHANTABILITY, NONINFRINGEMENT, FITNESS FOR PARTICULAR PURPOSE, OR ANY WARRANTY OTHERWISE ARISING OUT OF THIS SPECIFICATION. GS1 disclaims all liability for any damages arising from use or misuse of this Standard, whether special, indirect, consequential, or compensatory damages, and including liability for infringement of any intellectual property rights, relating to use of information in or reliance upon this document.

GS1 retains the right to make changes to this document at any time, without notice. GS1 makes no warranty for the use of this document and assumes no responsibility for any errors which may appear in the document, nor does it make a commitment to update the information contained herein.

GS1 and the GS1 logo are registered trademarks of GS1 AISBL.

Table of Contents

1	Business Domain View	5
1.1	Introduction	5
1.2	References	5
2	Business Context	6
3	Business Transaction View	6
3.1	Business Transaction - Receiving Advice	6
3.2	Business Transaction - Receipt Notification	8
4	Business Information View	10
4.1	Receiving Advice	10
4.2	Receiving Advice Line Item	14
4.3	Receiving Advice Logistic Unit	18
4.4	Receiving Advice Transport Information	19
4.5	Enumerations (message specific)	21
4.6	Code Lists	21
5	Business Message Examples	22
5.1	Example	22
6	Implementation Considerations	24
6.1	User Guide	24
6.2	Message Specific Considerations	24
7	Summary of Changes	25
7.1	BMS Release 3.0	25
7.2	BMS Release 3.1	25
7.3	BMS Release 3.2	26
7.4	BMS Release 3.3	27
7.5	BMS Release 3.4	29
7.6	BMS Release 3.4.1	29
8	Appendices	29
9	Acknowledgements	30
9.1	Work Group	30
9.2	Development Team Members	31

1 Business Domain View

1.1 Introduction

Message Definition

The Receiving Advice enables the receiver of the shipment to inform the shipper on the actual goods received, compared to what was advised as being sent.

Principles

Typical business uses of the receipt information can include – updating of inventory, identifying shipping discrepancies, and adjusting orders and related invoicing.

The Receiving Advice can be used in correlation with the Despatch Advice or other shipment documents to:

- Provide a simple acknowledgment that goods have been received
- Provide a detailed verification of actual goods received
- Provide notification of exceptions between shipment documentation (e.g. Despatch Advice and BOL) and actual receipts

1.2 References

Reference Name	Description
BMS eCom Domain Common Library Release 3.4	The documented design of components that are used in multiple messages within the eCom Domain.
BMS Shared Common Library Release 3.4	The documented design of components that are used in multiple messages within both GDSN and the eCom Domain.
BRAD Upstream Standards – Despatch, Receipt & Consumption 0.1.1	
BRAD Receiving Advice 2.1.1	
Business Requirements Analysis document (BRAD) for Current Requirements Queue (Major Release 3)	This BRAD is used to consolidate a list of requirements that have been submitted and approved by the eCom BRG as individual change requests. As such, each change request may have a different business justification as described by the original submitter. These change requests are listed in the " Change Request Reference " section.
BRAD Warehousing Inbound and Outbound Processes. [BRAD-WIO]	

2 Business Context

Context Category	Value(s)
Industry	All
Geopolitical	Global
Product	All
Process	Deliver
Official Constraints	None
Roles	Shipper, Ship From, Receiver, Ship To
System Capabilities	GS1 System, EANCOM, XML

3 Business Transaction View

3.1 Business Transaction - Receiving Advice

When the Receiver receives a shipment of goods from the Shipper, the Receiver compares the received goods to what was advised as despatched on the despatch advice or shipping documents, and creates and sends a Receiving Advice. The Receiver has the following options to choose from regarding what the Receiving Advice may contain:

- **Full** – details- Includes qualitative and/or quantitative details regarding everything received (all line items) whether or not there were exceptions between what was received and what was advised as being sent.
- **Exceptions** – Includes only qualitative and/or quantitative exceptions between what was received and what was advised as being sent.
- **Confirmation** – The acceptance of the receipt of goods.

Business Transaction Use Case Diagram

Not Applicable

Use Case Description

Use Case ID	
Use Case Name	Create and Send Receiving Advice
Use Case Description	Describes a complete process whereby a Receiver generates a Receiving Advice based on information gained from received goods and physical or electronic documents from a Shipper.
Actors (Goal)	Receiver and Shipper
Performance Goals	None
Preconditions	Master data alignment of locations (GLNs) and products (GTINs).
Post conditions	Indication of exceptions, full-detailed comparison or confirmation between goods received and goods advised as despatched.

Scenario	Begins when: The Receiver receives a shipment of goods accompanied or preceded by the Despatch Advice or Shipping Documents.	
	Continues with:	
	Step #	Actor
	1.	Receiver
	1.	Shipper
		Activity Step
		Sends Receiving Advice message to the Shipper
		Receives Receiving Advice Message
	Ends when: Receiver compares the received goods (as well as qualitative properties) to what was advised as being sent on the despatch advice or shipping documents.	
Alternative Scenario	Not Applicable	
Business Transaction Rules	1.	Receiving Advice will include full details OR exceptions OR a confirmation of the received goods compared to what was advised as being despatched on the despatch advice or shipping documents

Business Transaction Activity Diagram(s)

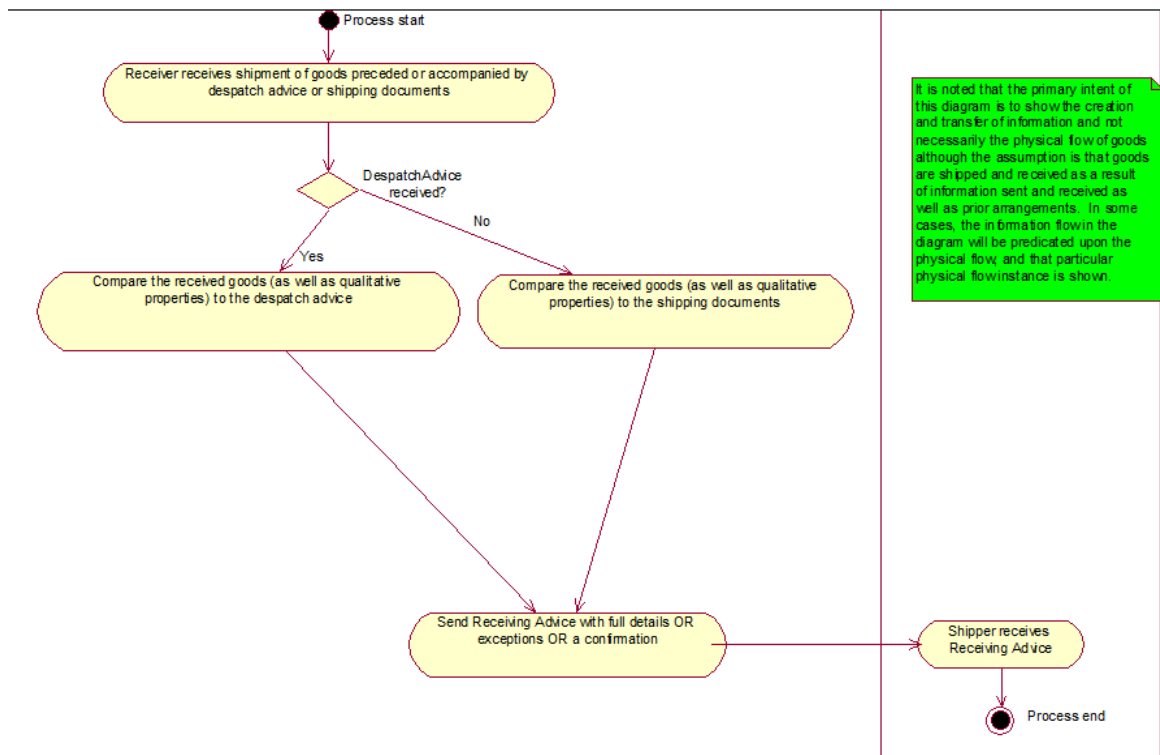

Business Transaction Sequence Diagram(s)

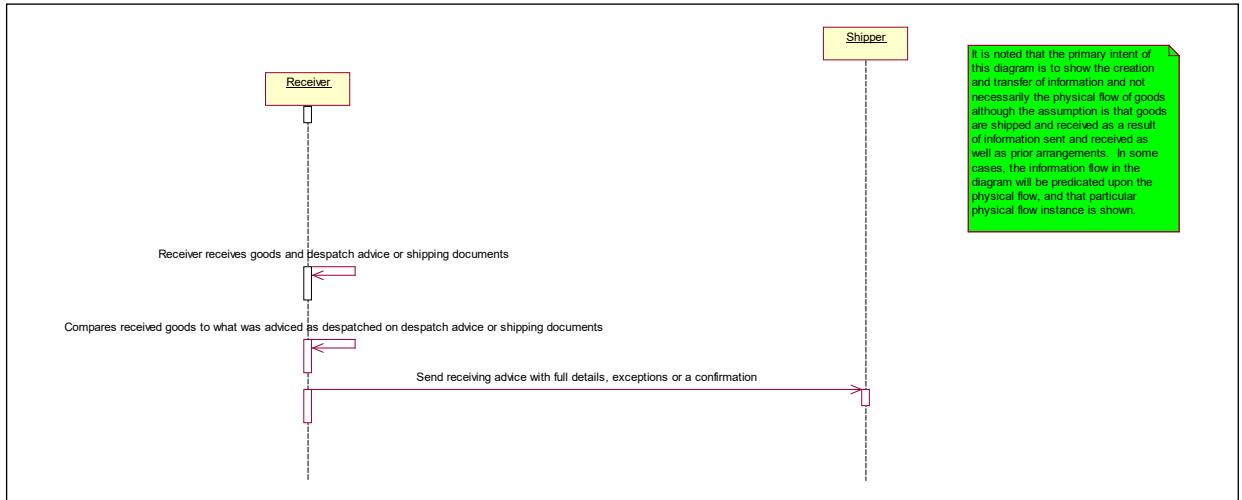

3.2 Business Transaction - Receipt Notification

Business Transaction Use Case Diagram

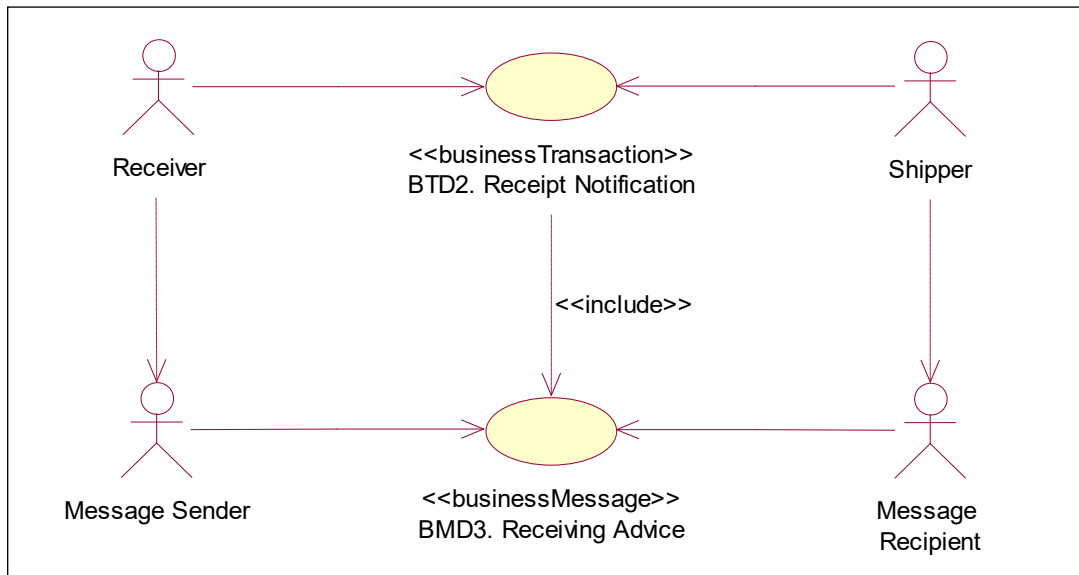

Use Case Description

Use Case ID	BTD2										
Use Case Name	Receipt Notification										
Use Case Description	Describes the receipt notification process.										
Actors (Goal)	Receiver: To inform the Shipper about the contents of a received shipment. Shipper: To be informed about the contents and conditions of the shipment at arrival at the destination.										
Performance Goals	The receipt notification must be sent shortly after the receipt of the shipment in order to avoid invoicing errors.										
Preconditions	GOODS: RECEIVED, COUNTED AND CHECKED DISPATCH NOTIFICATION: RECEIVED (BY RECEIVER)										
Post conditions	RECEIPT NOTIFICATION: RECEIVED (BY SHIPPER)										
Scenario	<p>Begins when:</p> <p>Continues with:</p> <table border="1"> <thead> <tr> <th>Step #</th> <th>Actor</th> <th>Activity Step</th> </tr> </thead> <tbody> <tr> <td>2.</td> <td>Receiver</td> <td>Sends Receiving Advice to the Ship From party.</td> </tr> <tr> <td>3.</td> <td>Shipper</td> <td>Receives the Receiving Advice.</td> </tr> </tbody> </table> <p>Ends when:</p>		Step #	Actor	Activity Step	2.	Receiver	Sends Receiving Advice to the Ship From party.	3.	Shipper	Receives the Receiving Advice.
Step #	Actor	Activity Step									
2.	Receiver	Sends Receiving Advice to the Ship From party.									
3.	Shipper	Receives the Receiving Advice.									
Alternative Scenario	Not Applicable										
Business Transaction Rules	Not Applicable										

4 Business Information View

4.1 Receiving Advice

Class diagram

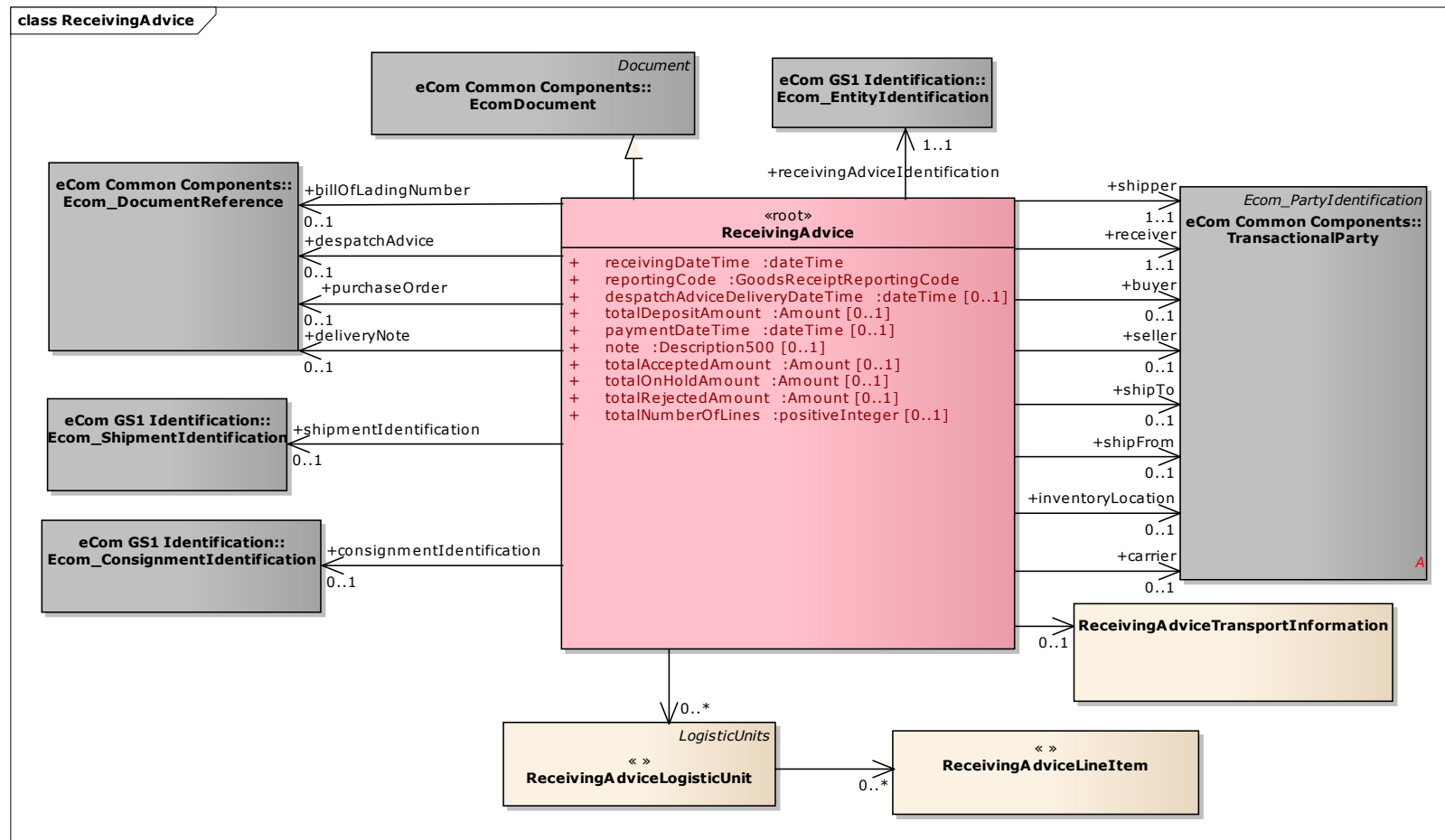

GDD report

The content of the ReceivingAdvice class, its structure and component definitions can be accessed in the Global Data Dictionary:

http://apps.gs1.org/GDD/bms/Version3_4/Pages/bieDetails.aspx?semanticURN=urn:gs1:gdd:bie:ReceivingAdvice

Content	Attribute / Role	Datatype / Secondaryclass	Multiplicity	Definition	Requirements
ReceivingAdvice				The Receiving Advice enables the receiver of the shipment to inform the shipper on the actual goods received, compared to what was advised as being sent.	
Association		ReceivingAdviceTransportInformation	0..1	Information with regards to the transportation and delivery of the shipment.	
Association	deliveryNote	Ecom_DocumentReference	0..1	The delivery note accompanying the shipment.	WR 15-000314
Association	despatchAdvice	Ecom_DocumentReference	0..1	Contains the reference to the despatch advice message to which the information in the receiving advice refers.	WR 15-000314
Association	buyer	TransactionalParty	0..1	Identifies the party to which products or services are sold.	
Generalization		EcomDocument		Basic information about the content of the message including version number, creation date and time and the placeholder for non-standard attributes.	
Association	shipTo	TransactionalParty	0..1	Identification of the location to where goods will be or have been shipped.	
Association	carrier	TransactionalParty	0..1	Uniquely identifies the entity that transports the shipment.	
Association	shipper	TransactionalParty	1..1	A party who engages in shipping goods. In a commercial scenario this would be the supplier.	
Association		ReceivingAdviceLogisticUnit	0..*	Contains detailed information about the received logistic units.	
Association	inventoryLocation	TransactionalParty	0..1	Identification of the location where the goods will be or have been stored.	



Receiving Advice Business Message Standard (BMS)

Content	Attribute / Role	Datatype / Secondaryclass	Multiplicity	Definition	Requirements
Association	receiver	TransactionalParty	1..1	A party who engages in receiving goods. In a commercial scenario this would be the customer.	
Association	shipFrom	TransactionalParty	0..1	Identification of the location from where goods will be or have been shipped.	
Association	purchaseOrder	Ecom_DocumentReference	0..1	Reference to the business document that triggered the delivery of the goods.;BRAD RQ 09.239	WR 15-000314
Association	consignmentIdentification	Ecom_ConsignmentIdentification	0..1	Number that identifies the consignment. (In case consignment consists of one shipment, it coincides with the shipment number).The Consignment Number, AI (401), is allocated by a freight forwarder, (or a carriers acting as a freight forwarder), or a consignor, but only if the prior agreement of the freight forwarder is given.	WR 15-000314
Association	shipmentIdentification	Ecom_ShipmentIdentification	0..1	Number that identifies the shipment.	WR 15-000314
Association	receivingAdviceIdentification	Ecom_EntityIdentification	1..1	Contains the unique identifier of the business document.	WR 15-000314
Association	billOfLadingNumber	Ecom_DocumentReference	0..1	Contains a reference to the bill of lading that accompanied the received goods.	WR 15-000314
Association	seller	TransactionalParty	0..1	Identifies the party which sells products or services to a buyer.	
Attribute	receivingDateTime	dateTime	1..1	Contains the date and time the goods were actually received.	
Attribute	reportingCode	GoodsReceiptReportingCode	1..1	Contains the type of receipt notification that is being communicated: partial or full.	
Attribute	despatchAdviceDeliveryDateTime	dateTime	0..1	Contains the planned delivery date time that was communicated in the despatch advice.	



Receiving Advice Business Message Standard (BMS)

Content	Attribute / Role	Datatype / Secondaryclass	Multiplicity	Definition	Requirements
Attribute	totalDepositAmount	Amount	0..1	Used to control if the total amount of the deposit corresponds to the number of bank notes of given value. This attribute is used for cash handling purposes.	WR 16-000245
Attribute	totalAcceptedAmount	Amount	0..1	Specifies the amount has been accepted. This attribute can be used e.g. for cash or paper coupon handling purposes.	WR 17-000042 WR 18-000136
Attribute	paymentDateTime	dateTime	0..1	The date on which the central bank has controlled the presumed false bank note that have been finally controlled as not false. This attribute is used for cash handling purposes.	WR 16-000250
Attribute	note	Description500	0..1	Free text used to convey information that is not processed by applications. Only meant to present the information to a user as on a screen, in a browser, etc.; BRAD RQ 09.236.F	
Attribute	totalRejectedAmount	Amount	0..1	Specifies the amount has been rejected. This attribute can be used e.g. for paper coupon handling purposes.	WR 17-000042
Attribute	totalOnHoldAmount	Amount	0..1	Specifies the amount has been put on hold. This attribute can be used e.g. for paper coupon handling purposes.	WR 17-000042
Attribute	totalNumberOfLines	positiveInteger	0..1	The number of all line items in the entire message	WR 17-000034



Note: Reference Shared Common Library Business Message (BMS) Release 3.4 and eCom Domain Common Library Business Message (BMS) Release 3.4 for all common information.

4.2 Receiving Advice Line Item

Class Diagram

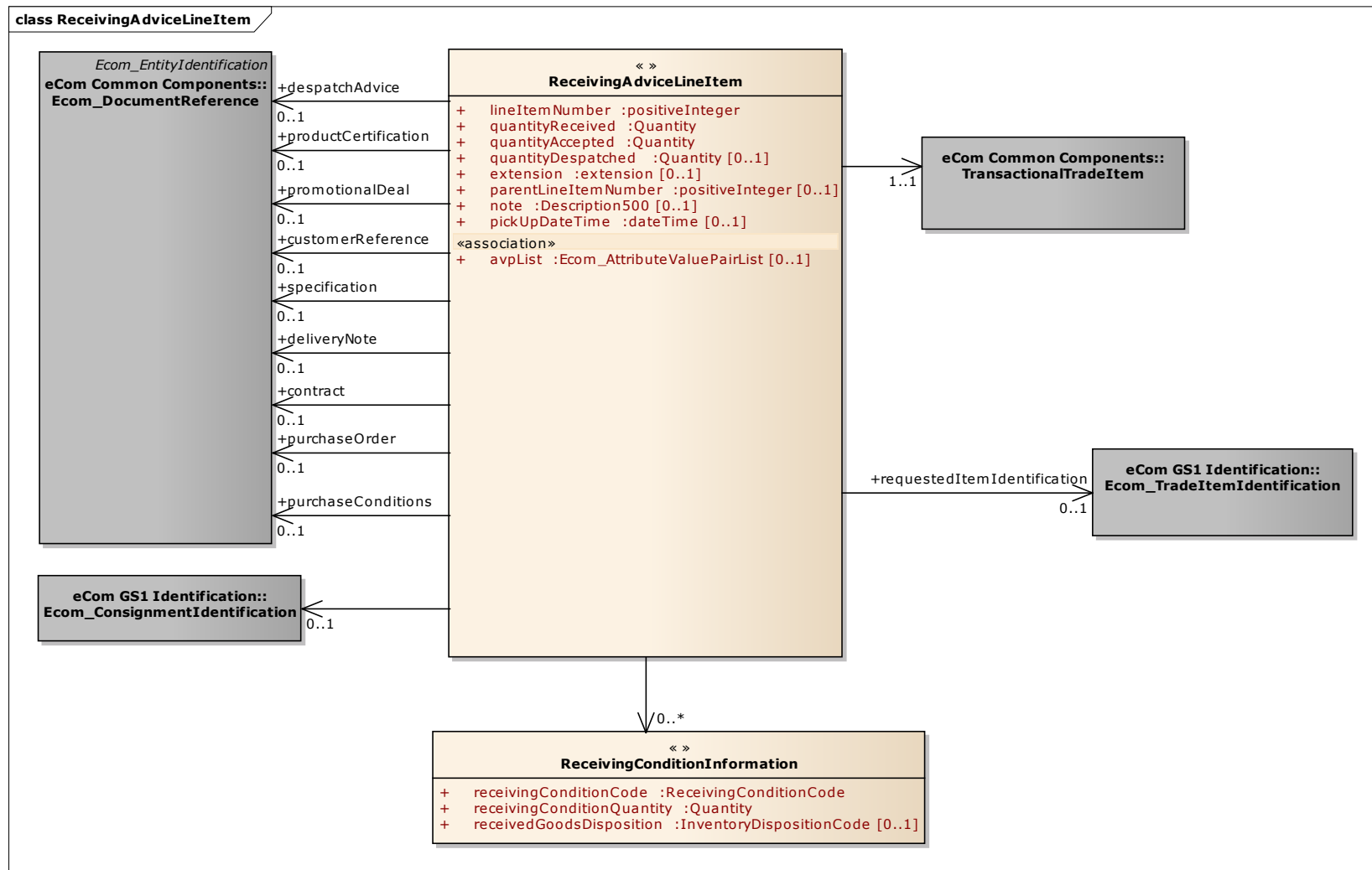

GDD Report

The content of the ReceivingAdviceLineItem class, its structure and component definitions can be accessed in the Global Data Dictionary:

http://apps.gs1.org/GDD/bms/Version3_4/Pages/bieDetails.aspx?semanticURN=urn:gs1:gdd:bie:ReceivingAdviceLineItem

Content	Attribute / Role	Datatype / Secondary class	Multiplicity	Definition	Requirements
ReceivingAdviceLineItem				Contains detailed information about the received goods.	MR3 renamed
Association	despatchAdvice	Ecom_DocumentReference	0..1	Contains the reference to the despatch advice line to which the information in the receiving advice line item refers	WR 15-000314
Association		ConsignmentIdentification	0..1	Contains the identification of the consignment	
Association		TransactionalTradeItem	1..1	Reference to the transactional trade item related to this line of the receiving advice.	
Association	contract	Ecom_DocumentReference	0..1	Reference to the contractual agreement under which the goods are delivered.	WR 15-000314
Association	promotionalDeal	Ecom_DocumentReference	0..1	Reference to a number assigned by a vendor to a special promotion activity.	WR 15-000314
Association	specification	Ecom_DocumentReference	0..1	An essential technical requirement for items, materials or services, including the procedures to be used to determine whether the requirement has been met. Specifications may also include requirements for preservation, packaging, packing, and marking.	WR 15-000314
Association	customerReference	Ecom_DocumentReference	0..1	Reference to the end customer that will receive the goods.	MR3 renamed from customer WR 15-000314
Association	purchaseConditions	Ecom_DocumentReference	0..1	Reference to the business document that describes the commercial conditions under which the goods are delivered.	WR 15-000314
Association	deliveryNote	Ecom_DocumentReference	0..1	Reference to the physical document that accompanies the delivered goods.	WR 15-000314
Association	productCertification	Ecom_DocumentReference	0..1	Reference to a number assigned by a governing body (or their agents) to a product which certifies compliance with a standard.	WR 15-000314



Content	Attribute / Role	Datatype / Secondary class	Multiplicity	Definition	Requirements
Association	purchaseOrder	Ecom_DocumentReference	0..1	Reference to the business document that triggered the delivery of the goods.	BRAD RQ 09.239 (was present in 2.5 already) WR 15-000314
Association		ReceivingConditionInformation	0..*	Contains information about the state of the received goods, such as discrepancies, quality issues, surpluses,	
Association	requestedItemIdentification	Ecom_TradeItemIdentification	0..1	Reference to the trade item identification for the requested trade item.	WR 15-000314
Attribute	lineItemNumber	positiveInteger	1..1	Provides the line number associated to the Receiving Advice Line Item.	
Attribute	quantityReceived	Quantity	1..1	Number of units received.	
Attribute	quantityAccepted	Quantity	1..1	Number of units accepted.	
Attribute	quantityDespatched	Quantity	0..1	Number of units despatched.	
Attribute	extension	extension	0..1	Extension point for inclusion of context specific information, such as information specific to a particular type of product. Example: Extension for meat products.	
Attribute	parentLineItemNumber	positiveInteger	0..1	The number of line item containing information about the parent of the current item. It allows establishing hierarchical link between the two items.	WR 14-000021 WR 14-000044
Attribute	pickUpDateTime	dateTime	0..1	Date/time at which the items are picked up.	WR 18-000136
Attribute	note	Description500	0..1	Free text used to convey information that is not processed by applications. Only meant to present the information to a user as on a screen, in a browser, etc.	BRAD RQ 09.236.F
Attribute	avpList	Ecom_AttributeValuePairList	0..1	Temporary attributes introduced between minor versions.	WR 14-000110

Content	Attribute / Role	Datatype /Secondary class	Multiplicity	Definition	Requirements
ReceivingConditionInformation				Contains information about the state of the received goods, such as discrepancies, quality issues, surpluses,	
Attribute	receivingConditionCode	ReceivingConditionCode	1..1	Contains a code that specifies the condition of the received goods.	
Attribute	receivingConditionQuantity	Quantity	1..1	Specification of discrepancies between quantity accepted, quantity received, quantity despatched	
Attribute	receivedGoodsDisposition	InventoryDispositionCode	0..1	Provides information what needs to be done with goods of specific receivingCondition.	WR 15-000282



Note: Reference Shared Common Library Business Message (BMS) Release 3.4 and eCom Domain Common Library Business Message (BMS) Release 3.4 for all common information.

4.3 Receiving Advice Logistic Unit

Class Diagram

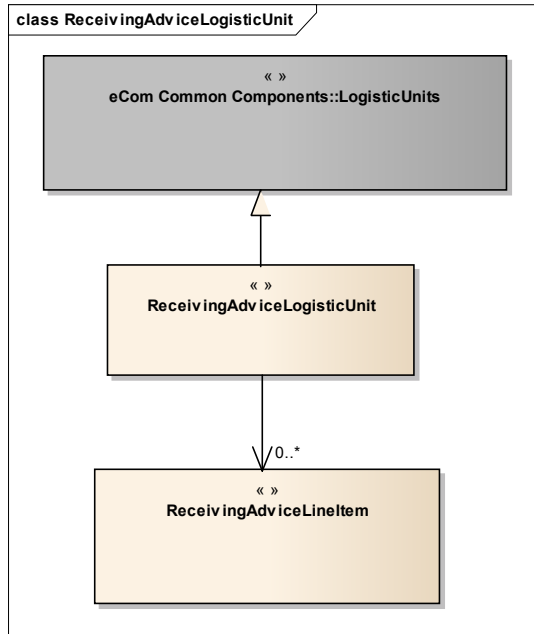

GDD Report

The content of the `ReceivingAdviceLogisticUnit` class, its structure and component definitions can be accessed in the Global Data Dictionary:

http://apps.gs1.org/GDD/bms/Version3_4/Pages/bieDetails.aspx?semanticURN=urn:gs1:gdd:bie:ReceivingAdviceLogisticUnit

Content	Attribute / Role	Datatype / Secondary class	Multiplicity	Definition	Requirements
ReceivingAdviceLogisticUnit				Contains detailed information about the received logistic units.	MR3 renamed
Generalization		LogisticUnits			
Association		ReceivingAdviceLineItem	0..*	Contains detailed information about the received goods.	



Note: Reference Shared Common Library Business Message (BMS) Release 3.4 and eCom Domain Common Library Business Message (BMS) Release 3.4 for all common information.

4.4 Receiving Advice Transport Information

Class Diagram

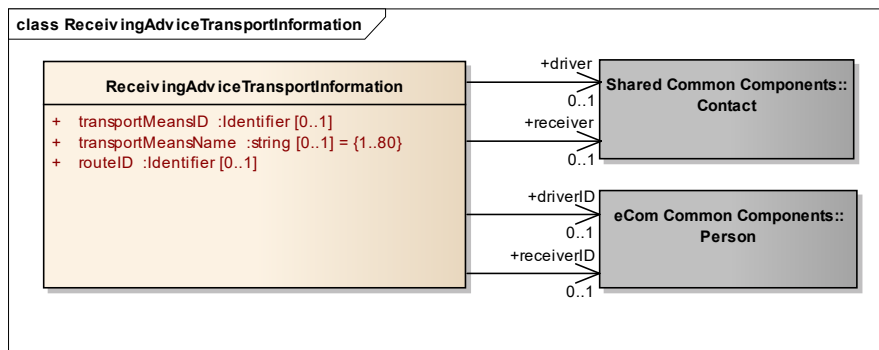

GDD Report

The content of the `ReceivingAdviceTransportInformation` class, its structure and component definitions can be accessed in the Global Data Dictionary:

http://apps.gs1.org/GDD/bms/Version3_4/Pages/bieDetails.aspx?semanticURN=urn:gs1:gdd:bie:ReceivingAdviceTransportInformation

Content	Attribute / Role	Datatype /Secondary class	Multiplicity	Definition	Requirements
ReceivingAdviceTransportInformation				Information with regards to the transportation and delivery of the shipment.	13-000203
Association	driverID	Person	0..1	Identification information about the driver of the transported goods.	13-000203
Association	receiver	Contact	0..1	Contact information to the person receiving the goods.	
Association	driver	Contact	0..1	Contact information to the driver of the transported goods	
Association	receiverID	Person	0..1	Identification information about the person receiving the goods.	13-000203



Content	Attribute / Role	Datatype /Secondary class	Multiplicity	Definition	Requirements
Attribute	transportMeansID	Identifier	0..1	Vehicle license plate/Aircraft number identifying a means of transport.	
Attribute	transportMeansName	string	0..1	The name, expressed as text, of a particular means of transport. E.g. The vessel name.	
Attribute	routeID	Identifier	0..1	Unique identifier of the standard route that will be used for this transport movement.	

4.5 Enumerations (message specific)

Not applicable

4.6 Code Lists

Class	Codelist	Referenced in
ReceivingAdvice	GoodsReceiptReportingCode	http://apps.gs1.org/GDD/Pages/clDetails.aspx?semanticURN=urn:gs1:gdd:cl:GoodsReceiptReportingCode
ReceivingConditionInformation	ReceivingConditionCode	http://apps.gs1.org/GDD/Pages/clDetails.aspx?semanticURN=urn:gs1:gdd:cl:ReceivingConditionCode



Note: Refer to the Global Data Dictionary (GDD) for the code values.

5 Business Message Examples

5.1 Example

This is an example of a Receiving Advice message. The message is sent on April 13th 2011 at 11.45 AM, for goods received on April 11th at 11PM. The message identification number is RA20051.

Party Information

GS1 Global Location Number	Party Type
5412345000013	Receiver
4098765000010	Shipper
5412345000037	Ship to

The Receiving Advice is sent by the Receiver (referred to as Buyer in Order, GLN 5412345000013) to the Shipper (referred to as Seller in Order, GLN 4098765000010).

The Receiver references the Despatch Advice # DA349875, sent on April 10th at 10:00 AM. The Receiver does not accept 10 items of the items identified with GTIN 40987650000223 – they have been damaged during transport. Items identified with GTIN 40987650000346 arrived in good condition and have been accepted.

Message Example

Attribute	Value
ReceivingAdvice	
Document	
creationDateTime	2011-04-13 11:45
documentStatusCode	ORIGINAL
EntityIdentification (+receivingAdviceIdentification)	
entityIdentification	RA20051
PartyIdentification (+contentOwner)	
gln	5412345000013
receivingDateTime	2011-04-11 23:00
reportingCode	FULL_DETAILS
TransactionalPartyIdentification (+shipper)	
gln	4098765000010
TransactionalPartyIdentification (+receiver)	
gln	5412345000013
TransactionalPartyIdentification (+shipTo)	
gln	5412345000037
DocumentReference (+despatchAdvice)	
EntityIdentification	
entityIdentification	DA349875
PartyIdentification (+contentOwner)	
gln	4098765000010
ReceivingAdviceLogisticUnit *1	
LogisticUnits	

Attribute	Value
packageTypeCode	PE (pallet, modular)
LogisticUnitIdentification	
sscc	409876506700001010
ReceivingAdviceLineItem *1.1	
lineItemNumber	1
quantityReceived	48
quantityAccepted	38
TradeItemIdentification (+requestedItemIdentification)	
gtin	40987650000223
DocumentReference (+despatchAdvice)	
entityIdentification	DA349875
lineItemNumber	1
ReceivingConditionInformation	
receivingConditionCode	DAMAGED_PRODUCT_OR_CONTAINER
receivingConditionQuantity	10
ReceivingConditionInformation	
receivingConditionCode	GOOD_CONDITION
receivingConditionQuantity	38
ReceivingAdviceLogisticUnit *2	
LogisticUnits	
packageType	PE (pallet, modular)
LogisticUnitIdentification	
sscc	409876506700099994
ReceivingAdviceLineItem *2.1	
lineItemNumber	2
quantityReceived	24
quantityAccepted	24
TradeItemIdentification (+requestedItemIdentification)	
gtin	40987650000346
DocumentReference (+despatchAdvice)	
entityIdentification	DA349875
lineItemNumber	2
ReceivingConditionInformation	
receivingConditionCode	GOOD_CONDITION
receivingConditionQuantity	24

6 Implementation Considerations

6.1 User Guide

The Functional User Guide contains more information about the structure and content of the message: http://www.gs1.org/docs/ecom/xml/3/3.4/eCom-Trade_messages.html#ReceivingAdvice

6.2 Message Specific Considerations

Not Applicable

7 Summary of Changes

Any change in the GS1 standards is done based on the Work Request (WR) submitted by the GS1 User Companies or Member Organisations. All Work Requests are documented in the Work Request system available on the GS1 website: <http://wr.gs1.org>. The system is accessible to registered users. New visitors need to register first, to be able to access it. WRs can be searched by the number referenced in tables below, see: Search Work Requests. The number starts with the two last digits of the year when it was submitted, followed by the consecutive number within that year.



Note: WRs submitted earlier than February 2012 should be searched in Old Change Requests.

7.1 BMS Release 3.0

Change	Associated CR
Added architectural principles section to the document, updated the GDD reports, class diagrams and test data sections to reflect the changes required by the CRQ BRAD and MR3.0	09-236 09-238 09-239 09-240
BMS Public Review: <ul style="list-style-type: none"> removed association from ReceivingAdvice to ReceivingAdviceLineItem, in order to have only one path to the line item (via ReceivingAdviceLogisticUnit). 	
BMS Publication: <ul style="list-style-type: none"> Updated date of document Clean-up of Document Change History Removed year from copyright statement in footer Attribute note in class ReceivingAdvice was missing def in GDD report. Fixed: "Free text used to convey information that is not processed by applications. Only meant to present the information to a user as on a screen, in a browser, etc." Was OK in GDD itself. Renamed uniqueCreatorIdentification into entityIdentification in examples Changed lowerCamelCase into lowercase for all GS1 keys in examples 	

7.2 BMS Release 3.1

Change	Associated CR
<div style="border: 1px solid black; padding: 10px;"> <p>class ReceivingAdvice - maintenance view</p> <div style="border: 1px solid black; padding: 5px; margin: 5px 0;"> <p style="text-align: center;">ReceivingAdvice</p> <p>+ receivingDateTime: dateTime + reportingCode: GoodsReceiptReportingCode + despatchAdviceDeliveryDateTime: dateTime [0..1] + note: Description500 [0..1]</p> <p style="text-align: center;">maintenance</p> <p>Change: (Verified) 3.1 added +buyer (BRAD WIO-RA-1) Change: (Verified) 3.1 added +seller (BRAD WIO-RA-2)</p> </div> </div>	BRAD WIO-RA-1, 2
corrected the SSCC number in the example.	

7.3 BMS Release 3.2

Change	Associated WR
<ul style="list-style-type: none"> ■ Added identification of (WR 13-203): <ul style="list-style-type: none"> □ Route □ transportMeansName □ Receiver – Contact □ Driver – Contact ■ Identify the Delivery note on header Level and the Package Quantity (WR 14-084) ■ Added Attribute Value Pair at the root, line item and sub line item levels (WR 14-110) <div style="border: 1px solid black; padding: 5px; margin-top: 10px;"> <p>class ReceivingAdvice - maintenance view</p> <div style="border: 1px solid black; padding: 5px; background-color: #f8d7da;"> <p style="text-align: center;">«root» ReceivingAdvice</p> <p>+ receivingDateTime :dateTime + reportingCode :GoodsReceiptReportingCode + despatchAdviceDeliveryDateTime :dateTime [0..1] + note :Description500 [0..1]</p> <p style="text-align: center;"><i>maintenance</i></p> <p>Change: (Complete) 3.1 added +buyer (BRAD WIO-RA-1) Change: (Complete) 3.1 added +seller (BRAD WIO-RA-2) Change: (Verified) 3.2 added association to DocumentReference named deliveryNote (WR 14-084) Change: (Verified) 3.2 added association to ReceivingAdviceTransportInformation (WR 13-203) Change: (Verified) 3.2 changed generalisation from Document to eComDocument class to include AVP (WR 14-110)</p> </div> </div>	<p>13-000203 14-000084 14-000110</p>
<ul style="list-style-type: none"> ■ Added a reference to parent line number to all LineItem classes, to support hierarchical items (WRs 14-021 & 14-044) ■ Added Attribute Value Pair at the root, line item and sub line item levels (WR 14-110) <div style="border: 1px solid black; padding: 5px; margin-top: 10px;"> <p>class ReceivingAdviceLineItem - maintenance view</p> <div style="border: 1px solid black; padding: 5px; background-color: #fff3cd;"> <p style="text-align: center;">« » ReceivingAdviceLineItem</p> <p>+ lineNumber :positiveInteger + quantityReceived :Quantity + quantityAccepted :Quantity + quantityDespatched :Quantity [0..1] + extension :extension [0..1] + parentLineNumber :positiveInteger [0..1] + note :Description500 [0..1] + «association» avpList :Ecom_AttributeValuePairList [0..1]</p> <p style="text-align: center;"><i>maintenance</i></p> <p>Change: (Verified) 3.2 added +avpList (WR 14-110) Change: (Verified) 3.2 added +parentLineNumber (WR 14-021 & 14-044)</p> </div> </div>	<p>14-000021 14-000044 14-000110</p>

Change	Associated WR
<ul style="list-style-type: none"> ■ Added identification of (WR 13-203): <ul style="list-style-type: none"> □ Route □ transportMeansName □ Receiver – Contact □ Driver – Contact <div style="border: 1px solid black; padding: 5px; margin-top: 10px;"> <p>class ReceivingAdviceTransportInformation - maintena...</p> <div style="border: 1px solid black; padding: 5px; margin: 5px;"> <p style="text-align: center;">ReceivingAdviceTransportInformation</p> <p>+ transportMeansID: Identifier [0..1] + transportMeansName: string [0..1] = {1..80} + routeID: Identifier [0..1]</p> <p style="text-align: center;"><i>maintenance</i></p> <p>Change: (Verified) 3.2 new class (WR 13-203)</p> </div> </div>	13-000203

7.4 BMS Release 3.3

Change	Associated WR
<ul style="list-style-type: none"> ■ Created Ecom_EntityIdentification class and changed association from the previous EntityIdentification ■ Created Ecom_DocumentReference class and changed association from the previous DocumentReference ■ Created Ecom_ConsignmentIdentification class and changed association from the previous ConsignmentIdentification ■ Created Ecom_ShipmentIdentification class and changed association from the previous ShipmentIdentification <div style="border: 1px solid black; padding: 5px; margin-top: 10px;"> <p>class ReceivingAdvice - maintenance view</p> </div>	15-000314 Make GS1 identification keys optional in GS1 EDI XML

Change	Associated WR
<p>Added +totalDepositAmount in ReceivingAdvice class Added +paymentDateTime in ReceivingAdvice class</p> <pre> class ReceivingAdvice - maintenance view «root» ReceivingAdvice + receivingDateTime :dateTime + reportingCode :GoodsReceiptReportingCode + despatchAdviceDeliveryDateTime :dateTime [0..1] + totalDepositAmount :Amount [0..1] + paymentDateTime :dateTime [0..1] + note :Description500 [0..1] maintenance Change: (Complete) 3.1 added +buyer (BRAD WIO-RA-1) Change: (Complete) 3.1 added +seller (BRAD WIO-RA-2) Change: (Complete) 3.2 added association to DocumentReference named deliveryNote (WR 14-084) Change: (Complete) 3.2 added association to ReceivingAdviceTransportInformation (WR 13-203) Change: (Complete) 3.2 changed generalisation from Document to eComDocument class to include AVP (WR 14-110) Change: (New) 3.3 added +paymentDateTime (WR 16-250) Change: (New) 3.3 added +totalDepositAmount (WR 16-245) Change: (New) 3.3 added role name consignmentIdentification to Ecom_consignmentIdentification for backward compatibility Change: (New) 3.3 added role name shipmentIdentification to Ecom_ShipmentIdentification for backward compatibility Change: (New) 3.3 changed association from ConsignmentIdentification to Ecom_ConsignmentIdentification (WR 15-314) Change: (New) 3.3 changed association from EntityIdentification to Ecom_EntityIdentification (WR 15-314) Change: (New) 3.3 changed association from ShipmentIdentification to Ecom_ShipmentIdentification (WR 15-314) Change: (New) 3.3 changed associations from DocumentReference to Ecom_DocumentReference (WR 15-314) </pre>	<p>16-000245 Add total amount of deposit at Receiving Advice level 16-000250 Add payment date time at Receiving Advice level</p>
<p>Added receivedGoodsDisposition to ReceivingConditionInformation Class associated to ReceivingAdviceLineItem</p> <pre> class ReceivingAdviceLineItem - maintenance view « » ReceivingConditionInformation + receivingConditionCode :ReceivingConditionCode + receivingConditionQuantity :Quantity + receivedGoodsDisposition :InventoryDispositionCode [0..1] maintenance Change: (New) 3.3 added +receivedGoodsDisposition (WR 15-282) </pre>	<p>15-000282 Add received goods disposition to Receiving Advice Line Item</p>

7.5 BMS Release 3.4

Change	Associated WR
<ul style="list-style-type: none"> ■ Added an optional element: totalNumberOfLines to the ReceivingAdvice class ■ Added an optional elements: totalAcceptedAmount, totalRejectedAmount and totalOnHoldAmount to the ReceivingAdvice class ■ Added totalAcceptedAmount to the ReceivingAdvice class <div style="border: 1px solid black; padding: 5px; margin-top: 10px;"> <p>class ReceivingAdvice - maintenance view</p> <pre style="background-color: #f9f9f9; padding: 5px;"> <<root>> ReceivingAdvice + despatchAdviceDeliveryDateTime :dateTime [0..1] + note :Description500 [0..1] + paymentDateTime :dateTime [0..1] + receivingDateTime :dateTime + reportingCode :GoodsReceiptReportingCode + totalDepositAmount :Amount [0..1] + totalAcceptedAmount :Amount [0..1] + totalRejectedAmount :Amount [0..1] + totalOnHoldAmount :Amount [0..1] + totalNumberOfLines :positiveInteger [0..1] maintenance Change: (Complete) 3.1 added +buyer (BRAD WIO-RA-1) Change: (Complete) 3.1 added +seller (BRAD WIO-RA-2) Change: (Complete) 3.2 added association to DocumentReference named deliveryNote (WR 14-084) Change: (Complete) 3.2 added association to ReceivingAdviceTransportInformation (WR 13-203) Change: (Complete) 3.2 changed generalisation from Document to eComDocument class to include AVP (WR 14-110) Change: (Complete) 3.3 added +paymentDateTime (WR 16-250) Change: (Complete) 3.3 added +totalDepositAmount (WR 16-245) Change: (Complete) 3.3 added role name consignmentIdentification to Ecom_consignmentIdentification for backward compatibility Change: (Complete) 3.3 added role name shipmentIdentification to Ecom_ShipmentIdentification for backward compatibility Change: (Complete) 3.3 changed association from ConsignmentIdentification to Ecom_ConsignmentIdentification (WR 15-314) Change: (Complete) 3.3 changed association from EntityIdentification to Ecom_EntityIdentification (WR 15-314) Change: (Complete) 3.3 changed association from ShipmentIdentification to Ecom_ShipmentIdentification (WR 15-314) Change: (Complete) 3.3 changed associations from DocumentReference to Ecom_DocumentReference (WR 15-314) Change: (New) 3.4 added +totalAcceptedAmount (WR 17-042 & 18-136) Change: (New) 3.4 added +totalNumberOfLines (WR 17-034) Change: (New) 3.4 added +totalOnHoldAmount (WR 17-042) Change: (New) 3.4 added +totalRejectedAmount (WR 17-042) </pre> </div>	<p>17-000034 Add number of lines to the receivingAdvice</p> <p>17-000042 Add total amount accepted, total amount rejected, total amount on hold to the receivingAdvice</p> <p>18-000136 Add Total deposit Accepted amount to the receivingAdvice</p>
<p>Added an optional element: pickUpDateTime to the ReceivingAdviceLineItem class</p> <div style="border: 1px solid black; padding: 5px; margin-top: 10px;"> <p>class ReceivingAdviceLineItem - maintenance view</p> <pre style="background-color: #f9f9f9; padding: 5px;"> << >> ReceivingAdviceLineItem + lineNumber :positiveInteger + quantityReceived :Quantity + quantityAccepted :Quantity + quantityDespatched :Quantity [0..1] + extension :extension [0..1] + parentLineNumber :positiveInteger [0..1] + note :Description500 [0..1] + pickUpDateTime :dateTime [0..1] <<association>> + avpList :Ecom_AttributeValuePairList [0..1] maintenance Change: (Complete) 3.2 added +avpList (WR 14-110) Change: (Complete) 3.2 added +parentLineNumber (WR 14-021 & 14-044) Change: (Complete) 3.3 changed association from ConsignmentIdentification to Ecom_ConsignmentIdentification (WR 15-314) Change: (Complete) 3.3 changed association from TradeItemIdentification to Ecom_TradeItemIdentification (WR 15-314) Change: (Complete) 3.3 changed associations from DocumentReference to Ecom_DocumentReference (WR 15-314) Change: (New) 3.4 added +pickUpDateTime (WR 18-136) </pre> </div>	<p>18-000136 Add pickUpDateTime to the receivingAdviceLineItem</p>

7.6 BMS Release 3.4.1

No work requests. Indirect changes due to upgrade to new Shared and eCom Common libraries.

8 Appendices

Not Applicable

9 Acknowledgements

9.1 Work Group

Function	Name	Company / organisation
Co-chair	Rossner (Pottier), Natascha	GS1 France
Co-chair	Schmidt, Tom Eric	August Storck KG
Member	Bemrose, Jonathan	R&R Ice Cream
Member	Bodemer, Petra	dm-drogerie markt GmbH + Co. KG
Member	Boikanyo, Rebone	GS1 South Africa / Consumer Goods Council of South Africa
Member	Canada, ON	M3B 3L1
Member	Carlson, Jim	General Mills, Inc.
Member	Chresta, Richard	GS1 Switzerland
Member	Cook, Don	Wal-Mart Stores, Inc.
Member	Cox, Marc	Philips Electronics N.V.
Member	Darnell, David	Systrends
Member	De Flou, Nele	GS1 Belgium & Luxembourg
Member	Dicks, Arne	GS1 Germany
Member	Duvinger, Karina	GS1 Sweden
Member	Foerderer, Klaus	GS1 Germany
Member	Gathmann, Stefan	GS1 Ireland
Member	Grangard, Anders	GS1 Global Office
Member	Harpell, Eileen	GS1 Community Room Staff
Member	Hand, Phil	JDA Software
Member	Herregodts, Kurt	GS1 Belgium & Luxembourg
Member	Kempkes, Fred	Unilever N.V.
Member	Kernan, Brendan	GS1 Ireland
Member	Kidd, Robin	Nestle
Member	Krid, Anne-Claire	GS1 France
Member	Lanoue, Tom	General Mills, Inc.
Member	Laur, Rita	GS1 Canada
Member	Lenman, Mia	GS1 Sweden
Member	Lerch, Hanjoerg	METRO Group
Member	Moberg, Dale	Axway
Member	Montes de Oca, Alejandra	GS1 Mexico
Member	Ng, Ella	GS1 Australia
Member	Peelen, Esther	GS1 Netherlands
Member	Pelekies, Andreas	GS1 Germany
Member	Perrier, Patricia	GS1 France
Member	Przybilla, Christian	GS1 Germany
Member	Pujol, Xavier	GS1 Spain
Member	Racek, Greg	Wal-Mart Stores, Inc.

Function	Name	Company / organisation
Member	Repetto, Mirko	GS1 Italy
Member	Robba, Steven	1WorldSync Holdings, Inc.
Member	Rosell, Pere	GS1 Spain
Member	Rosenberg, Steven	GS1 US
Member	Schmid, Sue	GS1 Australia
Member	Schneider, Christian	GS1 Switzerland
Member	Sehorz, Eugen	GS1 Austria
Member	Sharma, Vishal	General Mills, Inc.
Member	Shimazaki, Ayako	GS1 Japan
Member	Sion, Emilie	GS1 France
Member	Souza, Nadia	GS1 Brasil
Member	Strand, Roman	GS1 Germany
Member	Tan, Milton	GS1 Malaysia
Member	Tompsett, Simon	Waitrose
Member	Trelle, Ute	1WorldSync Holdings, Inc.
Member	Tse, Steve	GS1 Hong Kong
Member	Tyson, Betty	Knouse Foods Cooperative, Inc
Member	Van den Bergh, Senne	GS1 Belgium & Luxembourg
Member	Van der Eijk, Pim	OASIS - Sonnenglanz Consulting BV
Member	Veldhuis, Saskia	Procter & Gamble Co.
Member	Welch, Shan	GS1 UK
Member	Westerkamp, Jan	GS1 Netherlands
Member	Wilson, Mary	GS1 US
Member	Windsperger, Bekki	Best Buy Co., Inc.
Member	Yang, Shaopeng	GS1 China
Member	Yusdiar, Dani	GS1 Indonesia
Member	Zwanziger, Greg	SUPERVALU

9.2 Development Team Members

Function	Name	Organisation
GSMP Process Lead	Jean-Luc Champion and Tasha Wiehe	GS1 Global Office
Technical Development Lead	Ewa Iwicka	GS1 Global Office
Peer Review	Mark Van Eeghem	GS1 Global Office